

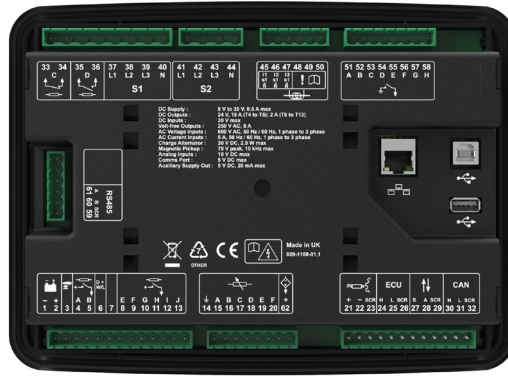

DSEG7400 Advanced Single Genset Controller

Part Number: G7400-01



Overview

The DSEG7400 is a remote start controller and an auto mains (utility) failure controller suitable for a wide variety of single, diesel or gas, genset applications. Monitoring an extensive number of engine parameters, the controller displays warnings, shutdown and engine status information on the back-lit LCD screen, illuminated LEDs and remote PC. The DSEG7400 can also monitor the mains (utility) supply.

The controller includes USB, RS485 and Ethernet ports as well as dedicated DSENet® terminals for system expansion. The controller is compatible with electronic (CAN) and non-electronic (magnetic pick-up/alternator sensing) engines and offers an extensive number of flexible inputs, outputs and engine protections so the system can be easily adapted to meet the most demanding industry requirements.

The list of features includes enhanced event and performance monitoring, remote communications and PLC functionality. Dual mutual standby is available using RS485 communications. This provides for a simpler and more convenient installation with more advanced features such as true hours balancing.

The controller also features SNMP functionality for connection to SNMP systems and can be easily configured using the DSE Configuration Suite PC software. Selected front panel editing is also available.

Key Features

- Cyber security ready architecture for today's connected power systems
- FuSa ready architecture for safety critical power applications
- Two controller applications in one (remote start control mode and auto mains (utility) failure control mode)
- Advanced PLC functionality including multi-purpose PIDs
- Flexible inputs and outputs
- DSENet® expansion support
- PC configuration using DSE Configuration Suite
- Multiple language support
- Enhanced 6-line high-resolution display with on screen application diagrams
- Integrated RS485 ports providing Modbus RTU support
- Integrated Ethernet port providing Modbus TCP, secure Modbus TCP and SNMP v2c
- Data logging of up to 60 parameters
- Multi-level PIN protected front panel editor
- Manual front panel and automatic control modes
- Latest ECU / ECM support for a wide range of engine manufacturers
- Dual mutual standby between two generators for redundancy and balance of engine hours

Product Approvals

- + CE
- + UL Listed: Standard - UL 6200:2019

Product Documentation

- 053-287 – DSEG7400 Installation Instructions
- 057-394 – DSEG7400 Operator Manual
- 057-393 – DSEG7400 Configuration Suite PC Manual



DEEP SEA ELECTRONICS UK
 T: +44 (0) 1723 890099
 E: sales@deepseaelectronics.com
 W: www.deepseaelectronics.com

DEEP SEA ELECTRONICS USA
 T: +1 (815) 316 8706
 E: usasales@deepseaelectronics.com
 W: www.deepseaelectronics.com

DEEP SEA ELECTRONICS UAE
 T: +971 (0) 45910819
 E: uaesales@deepseaelectronics.com
 W: www.deepseaelectronics.com

DEEP SEA ELECTRONICS INDIA
 T: +91 20 68195900
 E: sales@deepseaelectronics.com
 W: www.deepseaelectronics.com



DSEG7400 Advanced Single Genset Controller

Part Number: G7400-01

Manual / Remote Start Controller Key Features

- 3 phase generator sensing with protection.
- Manual starting/control by fascia button and remote starting/control by inputs and other functions.

Typical Application

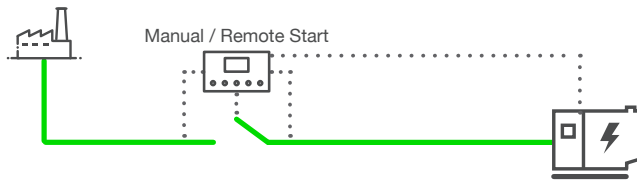

Automatic Mains (Utility) Failure (AMF) Controller Key Features

- 3 phase generator and mains (utility) sensing with protection.
- Manual starting/control by fascia button and remote starting/control by inputs and other functions.
- Automatic start and stopping of generator and transfer of load based on mains (utility) availability.

Typical Application

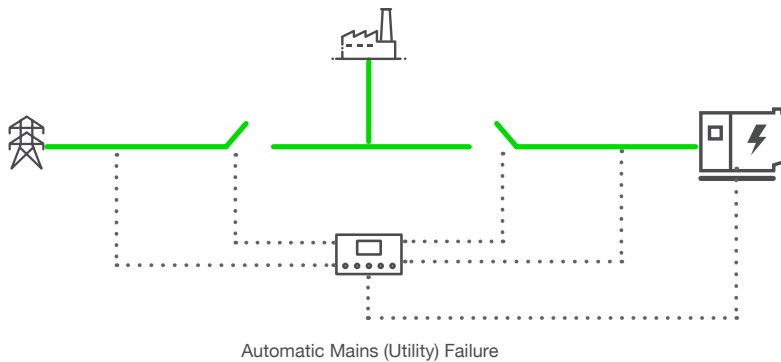

Product Documentation

- 053-287 – DSEG7400 Installation Instructions
- 057-394 – DSEG7400 Operator Manual
- 057-393 – DSEG7400 Configuration Suite PC Manual



DEEP SEA ELECTRONICS UK
 T: +44 (0) 1723 890099
 E: sales@deepseaelectronics.com
 W: www.deepseaelectronics.com

DEEP SEA ELECTRONICS USA
 T: +1 (815) 316 8706
 E: usasales@deepseaelectronics.com
 W: www.deepseaelectronics.com

DEEP SEA ELECTRONICS UAE
 T: +971 (0) 45910819
 E: uaesales@deepseaelectronics.com
 W: www.deepseaelectronics.com

DEEP SEA ELECTRONICS INDIA
 T: +91 20 68195900
 E: sales@deepseaelectronics.com
 W: www.deepseaelectronics.com

**DSEG7400** Advanced Single Genset Controller

Part Number: G7400-01

Specifications	
DC Supply	
Continuous Voltage Rating	8 V to 35 V DC continuous
Cranking Dropouts	Able to survive 0 V for 50 ms, providing supply was at least 5 V before dropout and supply recovers to 5 V. This is achieved without the need for internal batteries. Backlight will not be maintained during cranking.
Maximum Operating Current	640 mA at 12 V, 320 mA at 24 V
Maximum Standby Current	240 mA at 12 V, 120 mA at 24 V
Charge Alternator Excitation / Fail range	0 V to 35 V
Voltage Measurement	
Number	2
Measurement Inputs	3 Phase + Neutral Remote Start Controller: Generator Only Automatic Mains (Utility) Failure Controller: Generator and Mains (Utility)
Voltage Range	15 V to 415 V _{AC} Phase to Neutral 25 V to 720 V _{AC} Phase to Phase
Frequency Range	3.5 Hz to 75 Hz
Current Measurement	
Number	4
Measurement Inputs	3 Phase with Earth Fault Remote Start Controller: Generator Only Automatic Mains (Utility) Failure Controller: Generator or Load
Current Range	0 A to 1 A 0 A to 5 A
Analogue Inputs	
Number	6
Type	Configurable as Negative Switching Digital Input, Resistive Analogue Input, Current Analogue Input and Voltage Analogue Input.
Digital Input Closed Voltage Threshold	Less than 2.1 V
Digital Input Open Voltage Threshold	Greater than 6.6 V
Resistive Analogue Measurement Range	Input A, F: 0 to 3 kΩ Input B, C, D, E: 0Ω to 5 kΩ
Current Analogue Measurement Range	0 mA to 20 mA
Voltage Analogue Measurement Range	0 V to 10 V
Analogue Resolution	1 %
Analogue Accuracy	2 %

Product Documentation

053-287 – DSEG7400 Installation Instructions

057-394 – DSEG7400 Operator Manual

057-393 – DSEG7400 Configuration Suite PC Manual



DEEP SEA ELECTRONICS UK
 T: +44 (0) 1723 890099
 E: sales@deepseaelectronics.com
 W: www.deepseaelectronics.com

DEEP SEA ELECTRONICS USA
 T: +1 (815) 316 8706
 E: usasales@deepseaelectronics.com
 W: www.deepseaelectronics.com

DEEP SEA ELECTRONICS UAE
 T: +971 (0) 45910819
 E: uaesales@deepseaelectronics.com
 W: www.deepseaelectronics.com

DEEP SEA ELECTRONICS INDIA
 T: +91 20 68195900
 E: sales@deepseaelectronics.com
 W: www.deepseaelectronics.com



DSEG7400 Advanced Single Genset Controller

Part Number: G7400-01

Specifications	
Digital Inputs	
Number	8
Type	Negative Switching Digital Input
Closed Voltage Threshold	Less than 3.2 V
Open Voltage Threshold	Greater than 8.1 V
Emergency Stop Input	
Number	1
Type	Positive Switching Digital Input
Closed Voltage Threshold	Greater than 8.1 V
Low Voltage Threshold	Less than 3.2 V
Magnetic Pick-up Input	
Voltage Input Range	0.5 V _{Peak} to 70 V _{Peak}
Frequency Input Range	5 Hz to 10 kHz
Resolution	1 Hz
Accuracy	1%
Flywheel Teeth	10 to 500
Digital Outputs	
Number	10
Type	1 Normally Open Volt-Free Contact 1 Normally Closed Volt-Free Contact 8 Positive Switching DC Outputs
Volt-Free Contact Output Rating	8 A _{AC} resistive at 250 V _{AC} 5 A _{DC} resistive at 30 V _{DC}
Reference Output	50 mA at 5 V _{DC}
Positive DC Output Rating	Output A to B (Fuel and Start): 15 A _{DC} at Emergency Stop input supply voltage Output E to J: 2 A _{DC} at module supply voltage.

Product Documentation

053-287 – DSEG7400 Installation Instructions
 057-394 – DSEG7400 Operator Manual
 057-393 – DSEG7400 Configuration Suite PC Manual



DEEP SEA ELECTRONICS UK
 T: +44 (0) 1723 890099
 E: sales@deepseaelectronics.com
 W: www.deepseaelectronics.com

DEEP SEA ELECTRONICS USA
 T: +1 (815) 316 8706
 E: usasales@deepseaelectronics.com
 W: www.deepseaelectronics.com

DEEP SEA ELECTRONICS UAE
 T: +971 (0) 45910819
 E: uaesales@deepseaelectronics.com
 W: www.deepseaelectronics.com

DEEP SEA ELECTRONICS INDIA
 T: +91 20 68195900
 E: sales@deepseaelectronics.com
 W: www.deepseaelectronics.com



DSEG7400 Advanced Single Genset Controller

Part Number: G7400-01

Specifications	
Communications	
USB A	1 Data Storage Port
USB B	1 Programming Port
DSENet®	1 Expansion Port
RS485	1 Modbus RTU Port
Ethernet	1 10/100 Ethernet Port
CAN	2 Fully Isolated Ports CAN 1 – Engine ECU/ECM CAN 2 – Configurable CAN Communication
Temperature	
Operating Temperature	-30 °C to +70 °C / -22 °F to +158 °F
Storage Temperature	-40 °C to +85 °C / -40 °F to +185 °F
Dimensions	
Overall (W x H x D)	248.1 mm x 182.6 mm x 45.2 mm / 9.77" x 7.19" x 1.78"
Mounting	
Type	Panel Fascia Mounting
Panel Cut-Out (W x H)	220 mm x 160 mm / 8.66 " x 6.30 "
Maximum Panel Thickness	8 mm / 0.31 "

Product Documentation

053-287 – DSEG7400 Installation Instructions
 057-394 – DSEG7400 Operator Manual
 057-393 – DSEG7400 Configuration Suite PC Manual



DEEP SEA ELECTRONICS UK
 T: +44 (0) 1723 890099
 E: sales@deepseaelectronics.com
 W: www.deepseaelectronics.com

DEEP SEA ELECTRONICS USA
 T: +1 (815) 316 8706
 E: usasales@deepseaelectronics.com
 W: www.deepseaelectronics.com

DEEP SEA ELECTRONICS UAE
 T: +971 (0) 45910819
 E: uaesales@deepseaelectronics.com
 W: www.deepseaelectronics.com

DEEP SEA ELECTRONICS INDIA
 T: +91 20 68195900
 E: sales@deepseaelectronics.com
 W: www.deepseaelectronics.com



DSEG7400 Advanced Single Genset Controller

Part Number: G7400-01

Related Products		
DSEPower®		
DSEBC2415i	24 Volt, 15 Amp Intelligent Battery Charger	BC2415i-01
DSE2410Ei	12/24 Volt 10 Amp Enclosed Intelligent Battery Charger	BC2410Ei-02
DSE9476	24 Volt 20 Amp Intelligent Battery Charger	9476-01
DSE9474	24 Volt 30 Amp Intelligent Battery Charger	9474-01
DSE9470 MKII	24 Volt, 10 Amp Intelligent Battery Charger	9470-01
DSENet®		
DSE2548	DSENet® LED Output Expansion Module	2548-01
DSE2160	DSENet® Input / Output Expansion Module	2160-01
DSE2157	DSENet® Output Expansion Module	2157-01
DSE2152	DSENet® Analogue Output Expansion Module	2152-01
DSE2133	DSENet® RTD/Thermocouple Input Expansion Module	2133-01
DSE2131	DSENet® Ratiometric Input Expansion Module	2131-01
DSE2130	DSENet® Input Expansion Module	2130-00
DSEWebNet®		
DSE890 MKII	DSEWebNet® Gateway	0890-04
DSE891 MKII	DSEWebNet® / IoT Gateway - Ethernet Only	0891-04

Product Documentation

053-287 – DSEG7400 Installation Instructions
 057-394 – DSEG7400 Operator Manual
 057-393 – DSEG7400 Configuration Suite PC Manual



DEEP SEA ELECTRONICS UK
 T: +44 (0) 1723 890099
 E: sales@deepseaelectronics.com
 W: www.deepseaelectronics.com

DEEP SEA ELECTRONICS USA
 T: +1 (815) 316 8706
 E: usasales@deepseaelectronics.com
 W: www.deepseaelectronics.com

DEEP SEA ELECTRONICS UAE
 T: +971 (0) 45910819
 E: uaesales@deepseaelectronics.com
 W: www.deepseaelectronics.com

DEEP SEA ELECTRONICS INDIA
 T: +91 20 68195900
 E: sales@deepseaelectronics.com
 W: www.deepseaelectronics.com



DSEG7400 Advanced Single Genset Controller

Part Number: G7400-01

Environmental Testing Standards	
Electro-Magnetic Compatibility	
BS EN 61000-6-2	EMC Generic Immunity Standard for the Industrial Environment
BS EN 61000-6-4	EMC Generic Emission Standard for the Industrial Environment
Electrical Safety	
BS EN 61010	Safety Requirements for Electrical Equipment for Measurement, Control and Laboratory use
Temperature	
BS EN 60068-2-1	Ab/Ae Cold Test -30 °C
BS EN 60068-2-2	Bb/Be Dry Heat +70 °C
Vibration	
BS EN 60068-2-6	Ten sweeps in each of three major axes 5 Hz to 8 Hz at ±7.5 mm, 8 Hz to 500 Hz at 2 G _n
Humidity	
BS EN 60068-2-30	Db Damp Heat Cyclic 20/55 °C at 95% Relative Humidity 48 Hours
BS EN 60068-2-78	Cab Damp Heat Static 40 °C at 93% Relative Humidity 48 Hours
Shock	
BS EN 60068-2-27	Three shocks in each of three major axes 15 G _n in 11 ms
Degrees of Protection Provided by Enclosures	
BS EN 60529	IP65 - From the front of the module when installed into a control panel (Integrated Gasket)

Product Documentation

053-287 – DSEG7400 Installation Instructions
 057-394 – DSEG7400 Operator Manual
 057-393 – DSEG7400 Configuration Suite PC Manual



DEEP SEA ELECTRONICS UK
 T: +44 (0) 1723 890099
 E: sales@deepseaelectronics.com
 W: www.deepseaelectronics.com

DEEP SEA ELECTRONICS USA
 T: +1 (815) 316 8706
 E: usasales@deepseaelectronics.com
 W: www.deepseaelectronics.com

DEEP SEA ELECTRONICS UAE
 T: +971 (0) 45910819
 E: uaesales@deepseaelectronics.com
 W: www.deepseaelectronics.com

DEEP SEA ELECTRONICS INDIA
 T: +91 20 68195900
 E: sales@deepseaelectronics.com
 W: www.deepseaelectronics.com



DSEG7400 Advanced Single Genset Controller

Part Number: G7400-01

Advanced Single Genset Controller	
Pin	Description
1 to 2	DC Supply
3	Emergency Stop
4	Fuel
5	Start
6	Charger Alternator
7	Not Applicable
8 to 13	Digital Outputs
14 to 20	Analogue Inputs
21 to 23	Magnetic Pick-Up
24 to 26	Engine ECU/ECM
27 to 29	DSENet®
30 to 32	Configurable CAN
33 to 34	Normally Closed Volt Free Output
35 to 36	Normally Open Volt Free Output
37 to 40	Generator Voltage Sensing
41 to 44	Mains (Utility) Voltage sensing
45 to 50	Generator Current Sensing
51 to 58	Digital Inputs
59 to 61	RS485
62	V Ref (5V, 50mA)

Product Documentation

053-287 – DSEG7400 Installation Instructions
 057-394 – DSEG7400 Operator Manual
 057-393 – DSEG7400 Configuration Suite PC Manual



DEEP SEA ELECTRONICS UK
 T: +44 (0) 1723 890099
 E: sales@deepseaelectronics.com
 W: www.deepseaelectronics.com

DEEP SEA ELECTRONICS USA
 T: +1 (815) 316 8706
 E: usasales@deepseaelectronics.com
 W: www.deepseaelectronics.com

DEEP SEA ELECTRONICS UAE
 T: +971 (0) 45910819
 E: uaesales@deepseaelectronics.com
 W: www.deepseaelectronics.com

DEEP SEA ELECTRONICS INDIA
 T: +91 20 68195900
 E: sales@deepseaelectronics.com
 W: www.deepseaelectronics.com



DSEG7400 Advanced Single Genset Controller

Part Number: G7400-01

Technical Drawing

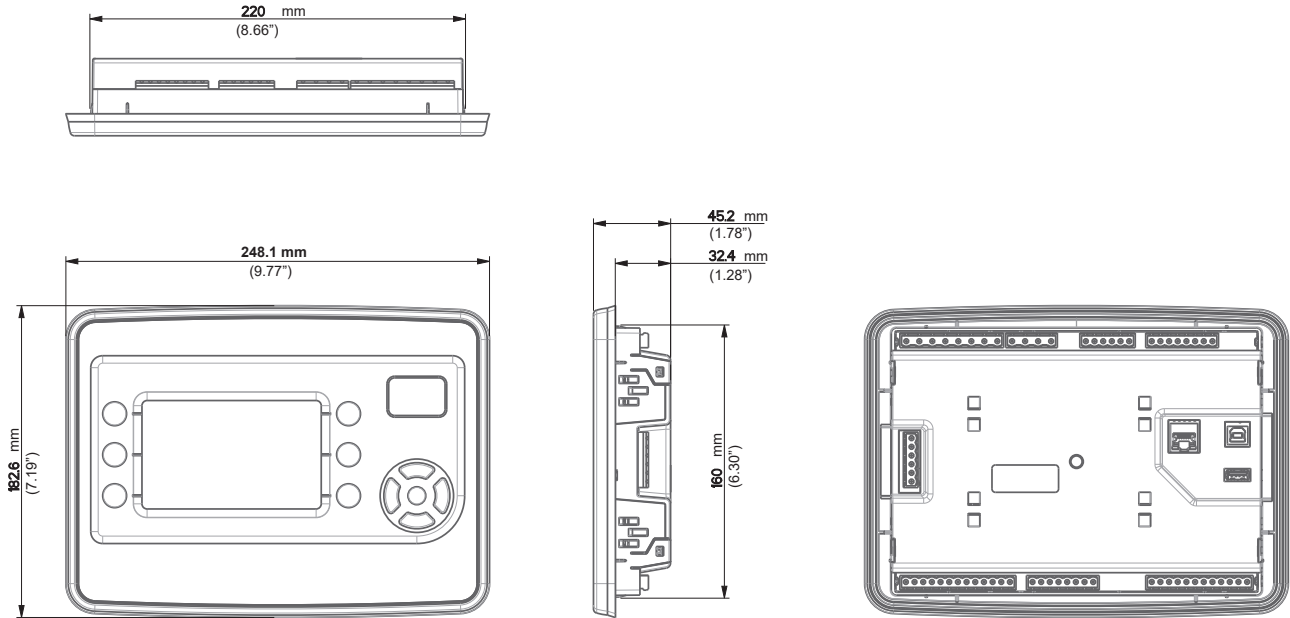

Connection Label

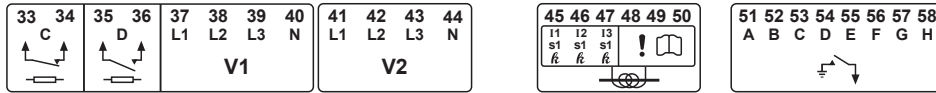

DC Supply : 8 V to 35 V, 0.5 A max
 DC Outputs : 24 V, 15 A (T4 to T5); 35 V, 2 A (T8 to T13)
 DC Inputs : 35 V max
 Volt-free Outputs : 250 V AC, 8 A
 AC Voltage inputs : 600 V AC, 50 Hz / 60 Hz, 1 phase to 3 phase
 AC Current inputs : 5 A, 50 Hz / 60 Hz, 1 phase to 3 phase
 Charge Alternator : 35 V DC, 2.5 W max
 Magnetic Pickup : 70 V peak, 10 kHz max
 Analog Inputs : 10 V DC max
 Comms Port : 5 V DC max
 Auxiliary Supply Out : 5 V DC, 50 mA max

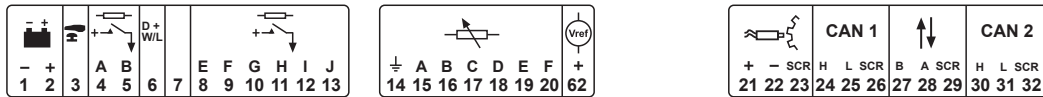
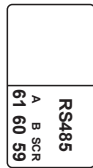

Refer to PIN out description charts for connection information on the operating mode controller is configured for.

Product Documentation

- 053-287 – DSEG7400 Installation Instructions
- 057-394 – DSEG7400 Operator Manual
- 057-393 – DSEG7400 Configuration Suite PC Manual



DEEP SEA ELECTRONICS UK
 T: +44 (0) 1723 890099
 E: sales@deepseaelectronics.com
 W: www.deepseaelectronics.com

DEEP SEA ELECTRONICS USA
 T: +1 (815) 316 8706
 E: usasales@deepseaelectronics.com
 W: www.deepseaelectronics.com

DEEP SEA ELECTRONICS UAE
 T: +971 (0) 45910819
 E: uaesales@deepseaelectronics.com
 W: www.deepseaelectronics.com

DEEP SEA ELECTRONICS INDIA
 T: +91 20 68195900
 E: sales@deepseaelectronics.com
 W: www.deepseaelectronics.com